

Multi-Mode Vibration Suppression in 2-DOF Piezoelectric Systems Using Zero Placement Input Shaping Technique

Yasser AL HAMIDI^{1,2} and Micky RAKOTONDRABE^{2,*}

¹Texas A&M University at Qatar, Doha, PO.Box 23874, Qatar

²AS2M department, FEMTO-ST Institute; CNRS UMR6174, University of Franche-Comté, ENSMM, UTBM; 24, rue Alain Savary Besançon France

*corresponding author: mrakoton@femto-st.fr

ABSTRACT

This paper deals with the feedforward control of the vibrations of a 2-DOF piezoelectric micropositioner in order to damp the vibrations in the direct axes and in the cross-couplings. The actuator exhibit badly damped vibrations in its direct transfers as well as in the cross-couplings transfers. We therefore propose a bivariable control which does not require sensors to reduce the vibrations in the different axes. The proposed scheme reduces all modes of vibrations for both outputs through extending the monovariable zero placement input shaping technique into bivariable. Experimental tests have been carried out and demonstrate the efficiency of the proposed method.

1 – INTRODUCTION

Piezoelectric cantilever structured actuators are well appreciated for the development of high precision and high dynamics positioning systems (micropositioners) thanks to their high bandwidth, high resolution and ease of powering (electrical). However these piezoelectric micropositioners exhibit badly damped vibrations due to the cantilever structures. These behaviors strongly affect the final performances, or even the stability, of the tasks to be executed. The increasing need on dexterous actuated systems led to the development of piezoelectric micropositioners with multiple degrees of freedom [1-4]. In [5], a 2-DOF piezoelectric micropositioner principle was patented. It is capable to perform microrobotic tasks such as micromanipulation with submicrometric resolution and along two axes [6, 7], see Figure 1. Nonetheless this micropositioner exhibits badly damped vibrations not only in the direct transfers but also in the cross-couplings transfers.

This paper deals with the feedforward control of the vibrations for the 2-DOF piezoelectric micropositioner in order to damp the vibrations in the direct axes and to reduce the cross-couplings. The novelty in this paper relative to the existing vibrations feedforward control, i.e. control without sensors, in piezoelectric systems [8-10] is the account for the strong cross-couplings vibrations. For that, we propose to extend the zero placement input shaping technique [11] to account for the direct transfers as well as the cross-couplings and to have more robustness relative to model uncertainties. Experimental tests on the 2-DOF piezoelectric micropositioner have been carried out and demonstrate the efficiency of the proposed method.

Input shaping is a well-known feedforward technique to reduce vibrations in flexible structures. Input shapers typically alter the original input command by a longer shaped command that is convolved with a set of impulses. Input shaping has been given a great deal of attention for single input systems with a multiple modes of vibrations in time and frequency domains [12...17]. For systems with multiple modes, shaped commands are typically constructed by cascading single-mode impulse sequences. Singer [15] illustrated that, although this approach was effective, shorter-length sequences typically would minimize distortion in the original command while eliminating all unwanted vibrations. Hyde [18] extended Singer's results by using non-linear, numerical search algorithms to construct time-optimal impulse sequences for multiple-mode systems. As an alternate approach, Smith indicated that Posicast inputs for multiple-mode systems could be constructed by placing zeros over all unwanted system poles in the z-plane. Although this technique was

never developed, Smith suggested that the discrete transfer function resulting from the specified zeros could then be used to construct a Posicast command to eliminate multiple-mode vibrations. As suggested by Smith, Tuttle and Seering [17] proposed practical zero-placement technique to design optimal input shapers for systems with arbitrary number of modes in the z-plane. In this technique, guidelines for effective shaper design become apparent which allow shaper performance to be better tailored to specific system requirements and provides a conceptually simple and highly effective strategy for suppressing vibrations in flexible mechanical systems. For systems with multiple inputs and multiple modes of vibrations, Pao [11] developed input shaping design technique which leads to a fewer number of impulses and hence shorter shaping delay and faster maneuvering.

For the remainder of this paper, we briefly review the existing input shaping method for multiple input systems (but single output) in section 2. Then, the proposed extended approach for multiple input multiple output systems is outlined in section 3. Finally, in section 4, the theoretical results is adapted and applied to a 2-DoF piezoelectric actuator which demonstrated its efficiency to reduce the vibrations both in the direct transfers and in the cross-couplings.

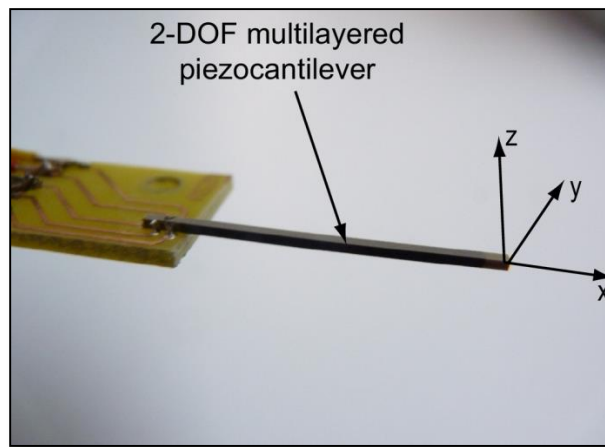

Figure 1: The two degrees of freedom (2-DOF) piezoelectric micropositioner.

2 – PRELIMINARIES ON MULTIPLE INPUT SHAPING AND SINGLE OUTPUT

This section explains an approach for designing input shapers for flexible structures with multiple inputs. Input shapers for multi-input systems with multi-modes of vibrations can be designed to be identical to each other by solving shaper constraint equations for only one sequence of impulses and apply it to all inputs. For large complex flexible structures, there are usually many flexible modes that need to be modeled, which may lead to relatively long time lags in the shaping sequence applies to all inputs! That is, it has been assumed in this approach that each input by itself must cancel out any vibrations that it causes by the end of its input command. Thus including more information about the flexible system model into the problem formulation and solving for the impulse sequences simultaneously generally lead to shorter sequences [11]. Let us assume a flexible structure with $m+1$ input, single output, and n structural frequencies $\omega_1 \dots \omega_n$

$$\begin{aligned} \dot{X}(t) &= \mathbf{A}X(t) + \mathbf{B}u(t) \\ y(t) &= \mathbf{C}X(t) \end{aligned} \tag{1}$$

Where

$$A = \text{blockdiag}[A_i] = \text{blockdiag} \begin{bmatrix} 0 & 1 \\ -\omega_i^2 & -2\zeta\omega_i \end{bmatrix}$$

For the rigid body $\zeta_0 = \omega_0 = 0$

And
$$B = \text{blockcol}[B_i] = \text{blockcol} \begin{bmatrix} 0 & 0 \dots & 0 \\ b_0^i & b_1^i \dots & b_m^i \end{bmatrix} \quad i = 0, 1, 2, \dots, n$$

The control vector is $u = [u_0 \ u_1 \ \dots \ u_m]^T$, and the state vector is $X = [x_1 \ x_2 \ x_3^1 x_4^1 \ \dots \ x_3^n x_4^n]^T$ where x_1 and x_2 are the rigid body position and velocity, and x_3^i and x_4^i are the modal positions and velocities. For rest-to-rest control of the flexible structure of Eq. (1), the objective is to determine the control functions $u(t)$ that satisfies actuator limits, so that the motion of the system is transferred from an initial rest state $X(0) = [x_{10} \ 0 \ 0 \ 0 \ \dots \ 0 \ 0]^T$ to a final rest state $X(t_f) = [x_{1f} \ 0 \ 0 \ 0 \ \dots \ 0 \ 0]^T$ with zero vibrations. The problem of coupling among inputs is addressed by including information from the B matrix of the system model in Eq. (1) into the derivation of the designed shapers. The transfer matrix from the unshaped inputs to the system states is $(sI - A)^{-1}BQ(s)$ where the multiple input shaper transfer functions are $Q_r(s)$, $r = 0, 1, 2, \dots, m$ and $Q(s)$ is a vector containing them. To filter out any vibrations due to the flexible mode, we choose $Q_r(s)$ such that:

$$b_0^i Q_0(s) + b_1^i Q_1(s) + \dots + b_m^i Q_m(s) |_{s=-\zeta_i \omega_i \mp j \omega_{d,i}} = 0 \quad (2)$$

Using the information in the B matrix gives us the constraints in Eq. (2), and simpler input shapers can be developed than those having zeros at all the flexible system poles. The desired impulse sequences (shapers) can then be solved for by taking the inverse Laplace transforms of $Q_r(s)$. If we assume the same T for all designed shapers then $Q_r(s)$ can be written in the following form:

$$Q_r(s) = a_{0r} + a_{1r}e^{-sT} + \dots + a_{lr}e^{-sLT} \quad (3)$$

Where $l = \left\lceil \frac{2n}{m+1} \right\rceil$ is the number of zeros that each of the shapers has.

By substituting $Q_r(s)$ in (2), the constraint equations can be re-written in the following matrix form:

$$Pa = W \quad (4)$$

Where

$$p = \begin{bmatrix} b_0^1 & b_0^1 e^{-s_1 T} & \dots & b_0^1 e^{-s_1 l T} & b_1^1 & b_1^1 e^{-s_1 T} & \dots & b_1^1 e^{-s_1 l T} & \dots & b_m^1 & b_m^1 e^{-s_1 T} & \dots & b_m^1 e^{-s_1 l T} \\ b_0^1 & b_0^1 e^{-s_1^* T} & \dots & b_0^1 e^{-s_1^* l T} & b_1^1 & b_1^1 e^{-s_1^* T} & \dots & b_1^1 e^{-s_1^* l T} & \dots & b_m^1 & b_m^1 e^{-s_1^* T} & \dots & b_m^1 e^{-s_1^* l T} \\ \dots & \dots & \dots & \dots & \dots & \dots & \dots & \dots & \dots & \dots & \dots & \dots & \dots \\ b_0^n & b_0^n e^{-s_n T} & \dots & b_0^n e^{-s_n l T} & b_1^n & b_1^n e^{-s_n T} & \dots & b_1^n e^{-s_n l T} & \dots & b_m^n & b_m^n e^{-s_n T} & \dots & b_m^n e^{-s_n l T} \\ b_0^n & b_0^n e^{-s_n^* T} & \dots & b_0^n e^{-s_n^* l T} & b_1^n & b_1^n e^{-s_n^* T} & \dots & b_1^n e^{-s_n^* l T} & \dots & b_m^n & b_m^n e^{-s_n^* T} & \dots & b_m^n e^{-s_n^* l T} \\ 1 & 1 & \dots & 1 & 0 & 0 & \dots & 0 & \dots & 0 & 0 & \dots & 0 \\ & & \dots & & & & \dots & & & & & \dots & \\ 0 & 0 & \dots & 0 & 0 & 0 & \dots & 0 & \dots & 1 & 1 & \dots & 1 \end{bmatrix} \quad (5)$$

$$a = [a_{00} \ a_{10} \ \dots \ a_{l0} \ a_{01} \ a_{11} \ \dots \ a_{l1} \ \dots \ a_{0m} \ a_{1m} \ \dots \ a_{lm}]^T \quad (6)$$

$W = \begin{bmatrix} \mathbf{0}_{2n \times 1} \\ \mathbf{1}_{(m+1) \times 1} \end{bmatrix}$, there are $2n + (m + 1)$ equations and $(l + 1)(m + 1)$ unknowns. For $l = \frac{2n}{m+1}$ there will be an equal number of equations and unknowns and \mathbf{a} can be solved using a generalized inverse:

$$\mathbf{a} = \mathbf{P}^\dagger \mathbf{W}. \quad (7)$$

As can be seen in this section, the design procedure of input shapers for flexible systems with multiple actuators is straightforward, simple to implement, and easily adaptable to various types of robustness constraints. Further, the resulting shaper designs have fewer impulses per input, and lead to shorter shaper lengths, thus yielding faster output responses.

3 – A NEW MULTIPLE INPUT MULTIPLE OUTPUT SHAPING

The same approach used in section 2 can be applied and extended to multiple output systems if we segregate the multi-input multi-output system (figure 2-a) into different number of systems equal to the number of outputs. Each of the resulting systems has the same number of inputs as the original system and only one output, figure 2-b. Following the same design method as the one in section 2 yields one $Q(s)$ solution of shapers for each output. However to be able to have one solution of shapers for all outputs, we have to include B_j information for all outputs in the shaper design process. That is, the designed shapers should be able to cancel all modes of vibrations for all outputs. In this section we propose creating a new state vector $X = [X_1 X_2 \dots X_K]^T$ that includes all state vectors $X_j = [x_{j1} \ x_{j2} \ x_{j3}^1 \ x_{j4}^1 \ \dots \ x_{j3}^n \ x_{j4}^n]^T$ where X_j represents the j^{th} output state vector, figure 2-b. The new input matrix $B = \text{blockcol}[B_j] = \text{blockcol}[\text{blockcol} \begin{bmatrix} 0 & 0 & \dots & 0 \\ b_{j0}^i & b_{j1}^i & \dots & b_{jm}^i \end{bmatrix}]$, figure 2-c, where $i = 0, 1, 2, \dots, n$ is the number of structural frequencies in each direction and $j = 1, 2, \dots, K$ is the number of outputs. The resultant constraint matrix $P = \text{blockcol}[P_j]$ and P_j is the same matrix shown in equation (5) for each of the outputs, taking into consideration that the unity constraint for impulse amplitudes of each of the shapers should not be repeated more than once. Additionally the number of shaper impulses will be increased by K factor $l = \left\lceil \frac{(2n)K}{m+1} \right\rceil$ if we would like to maintain the equation between constraint equations and unknowns.

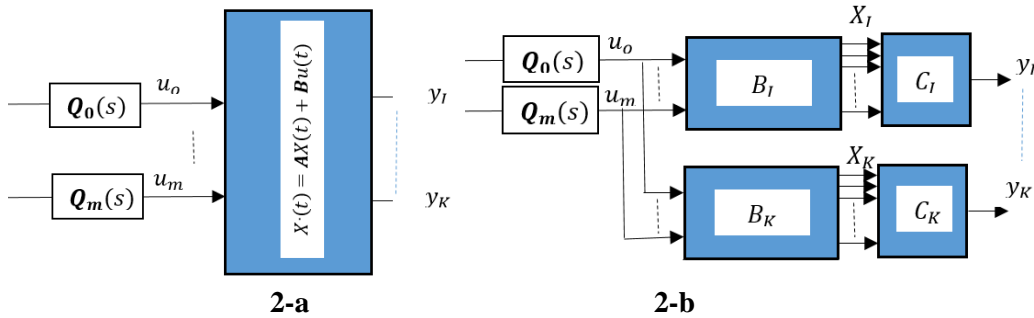

(9)

By using system identification toolkit of MATLAB with the recorded step responses of the system in figure 1, a model of the system and its poles were derived. From the system model, input matrix \mathbf{B} as per equation (8) was identified and vector \mathbf{a} was calculated as per equations (7) and (9). The spacing between impulses was assumed to be the same for both shapers, and its value T was selected to have all impulse amplitudes for both shapers positive. Figure 3 shows the simulation results of both, direct and cross-coupling output responses when exciting one of the inputs only. Figure 4 shows the experimental results after applying the designed compensator on the actual piezoactuator. The simulation and experimental results show that the controller was greatly successful in suppressing vibrations for both the direct and the cross-coupling outputs. The suppression in the experimental results is not as good as in the simulation results due to some modeling error. To be more robust against modeling errors, the compensator performance towards having better vibrations suppression can be probably improved by increasing the number of impulses in each of the designed shapers, this will be on the expense of having more delay in the shaped inputs.

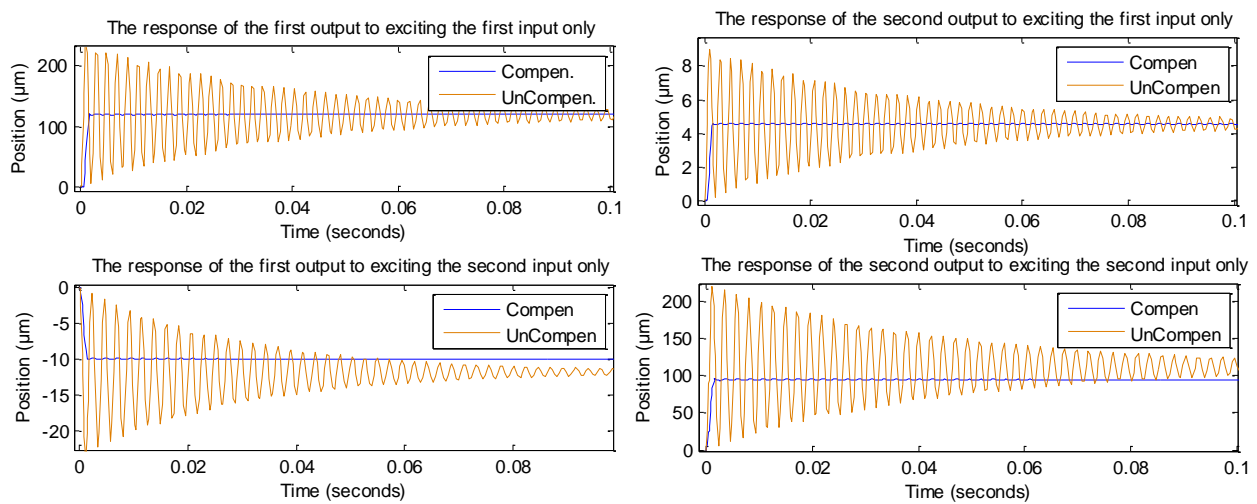

Figure 3- Exciting one input and showing the cross coupling effect – simulation

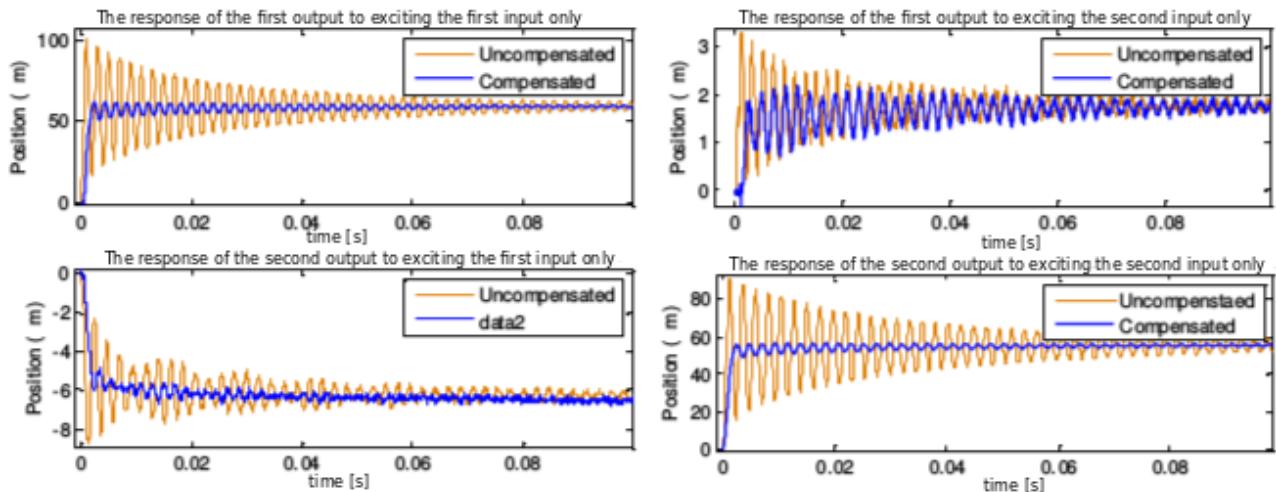

Figure 4- Exciting one input and showing the cross coupling effect – experimental

Figures 5 and 6 show the simulation and experimental results for the compensated and non-compensated outputs when we fully excite both inputs. As the selected spacing time T is $\frac{1}{4}$ of the system fundamental frequency and shapers are constituted from four impulses, the near-zero vibrations happen exactly after a complete cycle of the non-compensated response in both, the simulation and experimental results.

To examine the effectiveness of the designed controller the frequency responses of the compensated and un-compensated, direct and cross-coupling systems were plotted in figure 7. These results evidence the reduction of the resonance peaks in the direct transfers and in the cross-couplings which therefore demonstrate the efficiency of the approach.

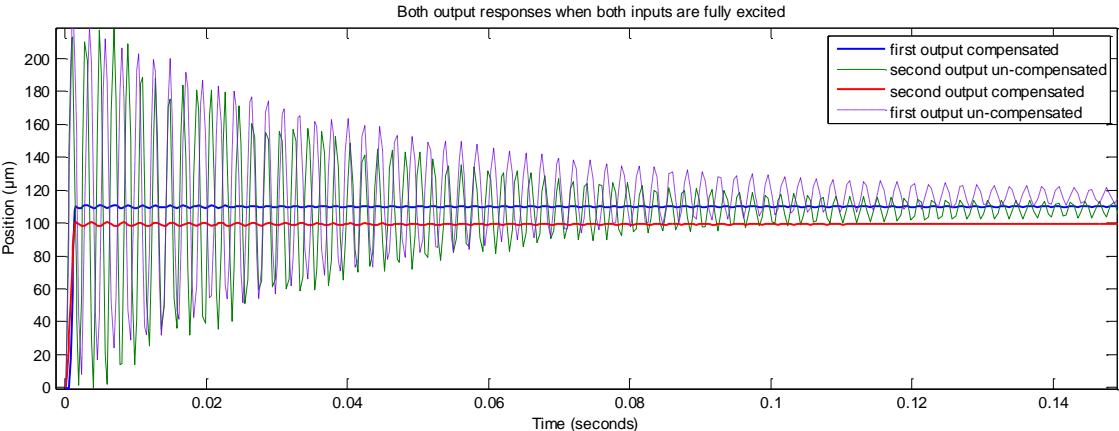

Figure 5- Exciting both inputs and showing both outputs, compensated and non-compensated - simulation

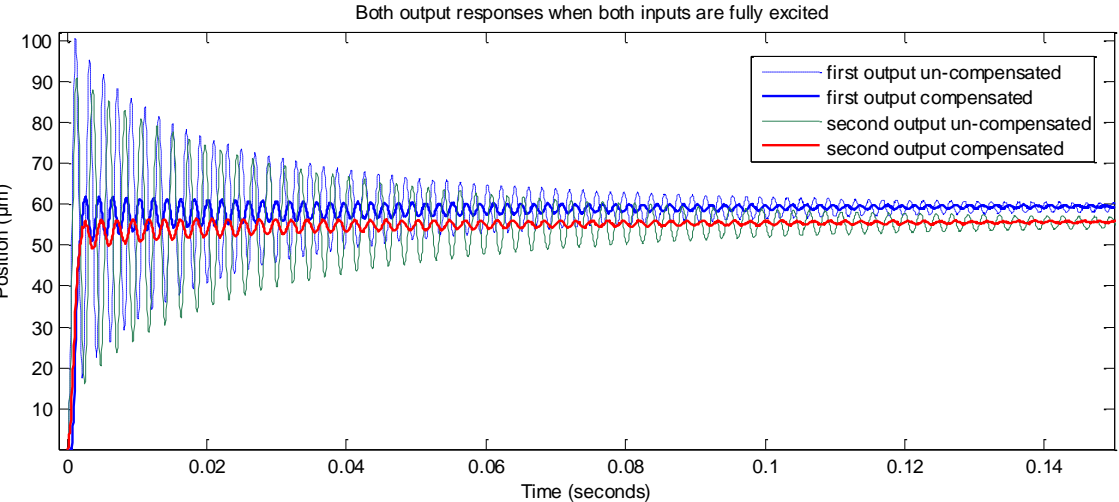

Figure 6- Exciting both inputs and showing both outputs, compensated and non-compensated – experimental

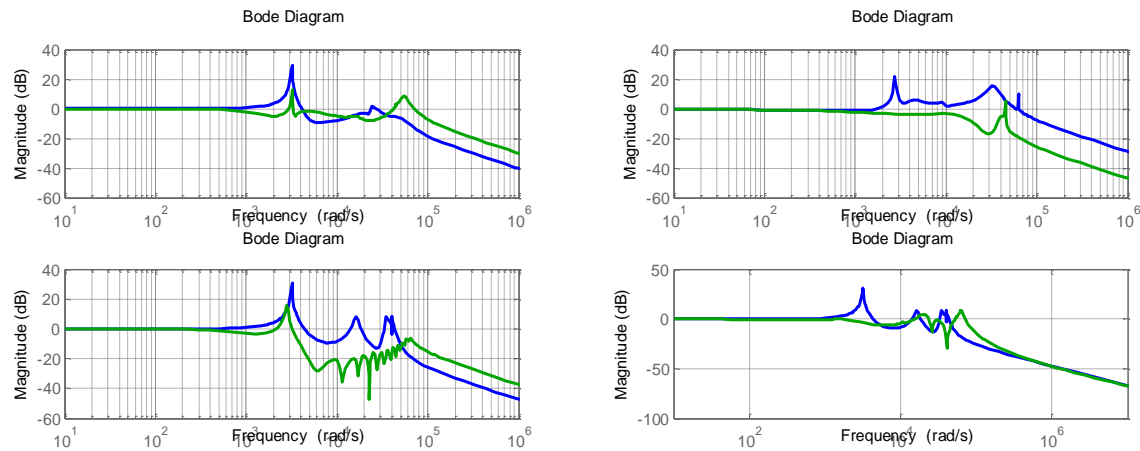

Figure 7- Compensated and un-compensated system frequency responses

5 – CONCLUSION AND PERSPECTIVES

This paper proposed the damping of vibrations in oscillating multi-DOF systems with an application to a 2-DOF piezoelectric cantilevered actuator by using feedforward controllers. Such systems are characterized by badly damped vibrations in both the direct transfers and in the cross-couplings transfers. These vibrations are unwanted since they decrease the overall performances of the systems, strongly compromise their stability and render difficult the synthesis of closed-loop controllers. The paper proposed therefore to compensate for the vibrations by extending into multi-input-multi-output the multi-input-single-output zero placement input shaping technique. Experiments were carried out and confirmed the efficiency of the approach.

6 – ACKNOWLEDGMENTS

This work is supported by the national ANR-JCJC C- MUMS-project (National young investigator project ANR-12- JS03007.01: Control of Multivariable Piezoelectric Microsystems with Minimization of Sensors). This work is also supported by the LABEX ACTION.

7 – REFERENCES

- [1] Micky Rakotondrabe, YassineHaddab, Philippe Lutz, "Design, development and experiments of a high stroke-precision 2DoF (linear-angular) microsystem", IEEE International Conference on Robotics and Automation ICRA, pp.669-674, May 2006.
- [2] G. Binnig, C. F. Quate, Ch. Gerber, "Atomic Force Microscope". Physical Review Letters 56 (9): 930–933, 1986.
- [3] B. J. Kenton, K. K. Leang (2012): Design and control of a three-axis serial-kinematic high-bandwidth nanopositioner. IEEE/ASME Trans. Mechatronics, 17 (2), pp. 356 – 369, 2012.
- [4] W. Liao, W. Liu, Y. Zhu, Y. Tang, B. Wang, and H. Xi, "A Tip-Tilt-Piston Micromirror With Symmetrical Lateral-Shift-Free Piezoelectric Actuators", IEEE Sensors Journal, 13(8), pp. 2873-2881, 2013.
- [5] J. Agnus, P. De Lit and N. Chaillet, "Micromanipulateur piézoélectrique notamment pour microrobotique", french patent, FR0211934, 2002.
- [6] Micky Rakotondrabe, JoëlAgnus and Philippe Lutz, 'Feedforward and IMC-feedback control of a nonlinear 2-DOF piezoactuator dedicated to automated micropositioning tasks', IEEE - CASE, (International Conference on Automation Science and Engineering), pp.393-398, Trieste Italy, August 2011.
- [7] JoëlAgnus, Nicolas Chaillet, Cédric Clévy, Soukalo Dembélé, Michaël Gauthier, Yassine Haddab, Guillaume Laurent, Philippe Lutz, Nadine Piat, Kanty Rabenorosoa, Micky Rakotondrabe and Brahim

- Tamadazte, 'Robotic Microassembly and micromanipulation at FEMTO-ST', Journal of Micro-Bio Robotics (JMBR), Volume 8, Issue 2, Page 91-106, 2013.
- [8] Micky Rakotondrabe, Cédric Clévy and Philippe Lutz, 'Hysteresis and vibration compensation in a nonlinear unimorph piezocantilever', IEEE/RSJ - IROS, (International Conference on Intelligent Robots and Systems), pp:558-563, Nice France, Sept 2008.
- [9] Micky Rakotondrabe, Cédric Clévy and Philippe Lutz, 'Complete open loop control of hysteretic, creeped and oscillating piezoelectric cantilever', IEEE - Transactions on Automation Science and Engineering (T-ASE), Vol.7(3), pp:440-450, July 2010.
- [10] D. Croft, G. Shed and S. Devasia, "Creep, hysteresis and vibration compensation for piezoactuators: atomic force microscopy application", ASME Journal of Dynamic Systems, Measurement and Control, 2001.
- [11] Pao, L. Y. "Multiple Input-Shaping Design for Vibration Reduction," Automatica, 35(1), pp. 8 1-89, January 1999.
- [12] Bhat, S. P. and D. K. Miu. "Solutions to Point-to-Point Control Problems Using Laplace Transform Technique," ASME J. Dynamic Systems, Measurement, and Control, 113(3): 425-431, Sept. 1991
- [13] Hyde, J. M. and W. P. Seering. "Using Input Command Pre-Shaping to Suppress Multiple Mode Vibration," Proc. IEEE Robotics and Automation Conf., Sacramento, CA, pp. 2604-2609, April 1991.
- [14] Singer, N. and W. P. Seering. "Preshaping Command Inputs to Reduce System Vibration," ASME J. Dynamic Systems, Measurement, and Control, 1 12(1): 76-82, March 1990.
- [15] Rappole, B. W., N. C. Singer, and W. P. Seering. "Multiple-Mode Input Shaping Sequences for Reducing Residual Vibrations," ASME Mechanisms Conf., 1994.
- [16] Singh, T. and S. R. Vadali. "Robust Time-Optimal Control: A Frequency Domain Approach," Proc. AZAA Guidance, Navigation, and Control Conf., Scottsdale, AZ, pp. 241-251, Aug. 1994.
- [17] Tuttle, T. D. and W. P. Seering. "A Zero-Placement Technique for Designing Shaped Inputs to Suppress Multiple-mode Vibration," Proc. American Control Conf., Baltimore, MD pp. 2533-2537, June 1994
- [18] Hyde, J.M. and W.P. Seering, "Using Input Command Pre-Shaping to Suppress Multiple Mode Vibration," Proceedings of the IEEE International Conference on Robotics and Automation, Sacramento, CA, 1991, p. 2604-2609.